

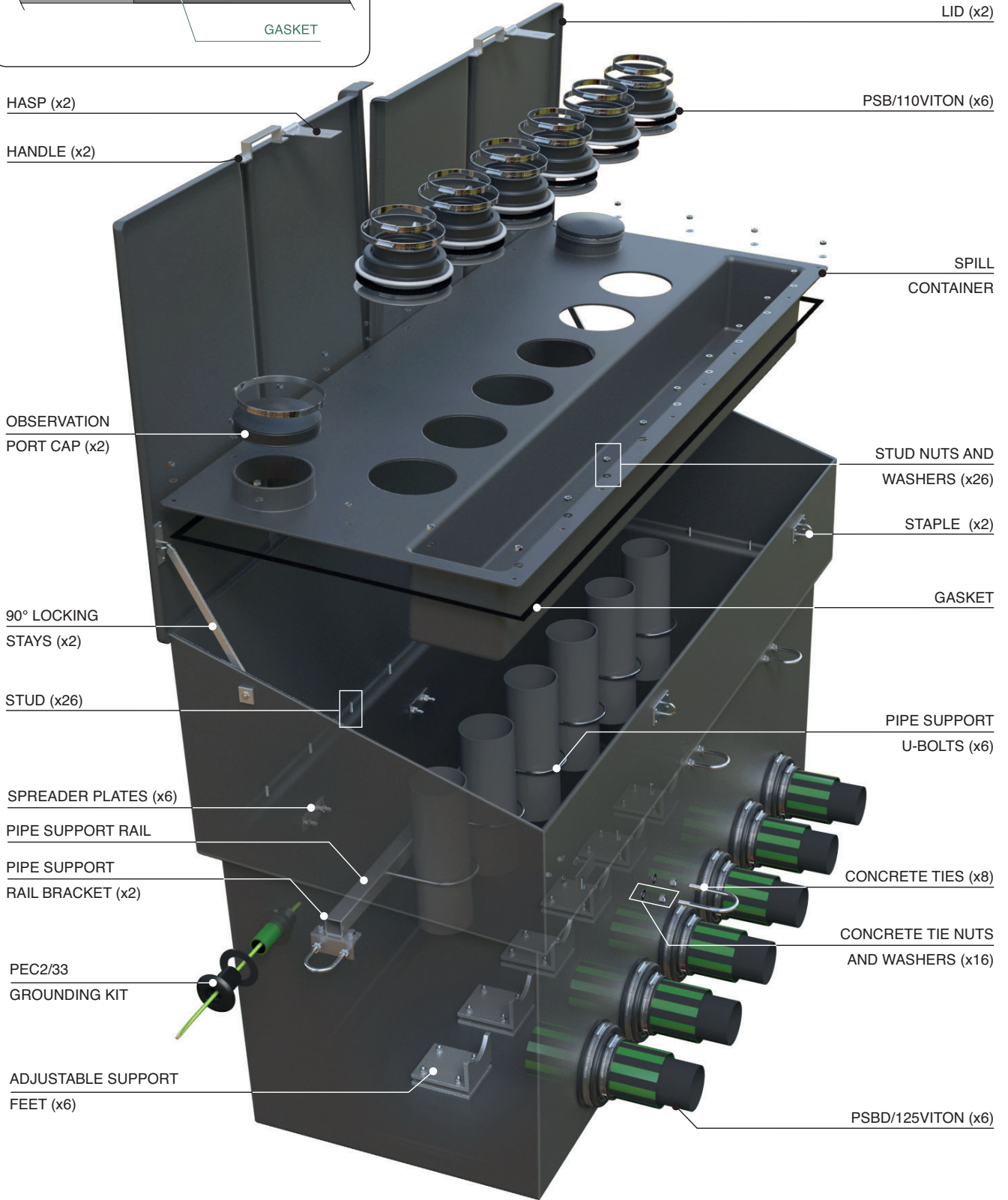

1737 x 686 x 1257mm deep GRP above ground fill sump with hinged double door to fit up to 6 fill lines. System includes internal spill tray, pipework support rail and concrete tie fixings.

For reference purposes only. This drawing is not a specification. Order against product code only. To enable continuous improvement of our products, the designs and specifications are subject to change without notice.

**LID INTERFACE DETAIL  
IN THE CLOSED POSITION**

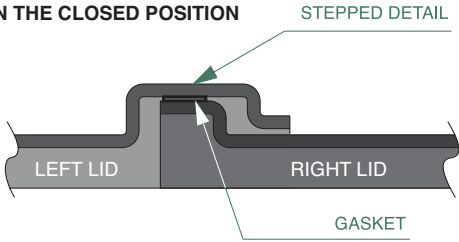

1737 x 686 x 1257mm deep GRP above ground fill sump with hinged double door to fit up to 6 fill lines. System includes internal spill tray, pipework support rail and concrete tie fixings.

For reference purposes only. This drawing is not a specification. Order against product code only. To enable continuous improvement of our products, the designs and specifications are subject to change without notice.



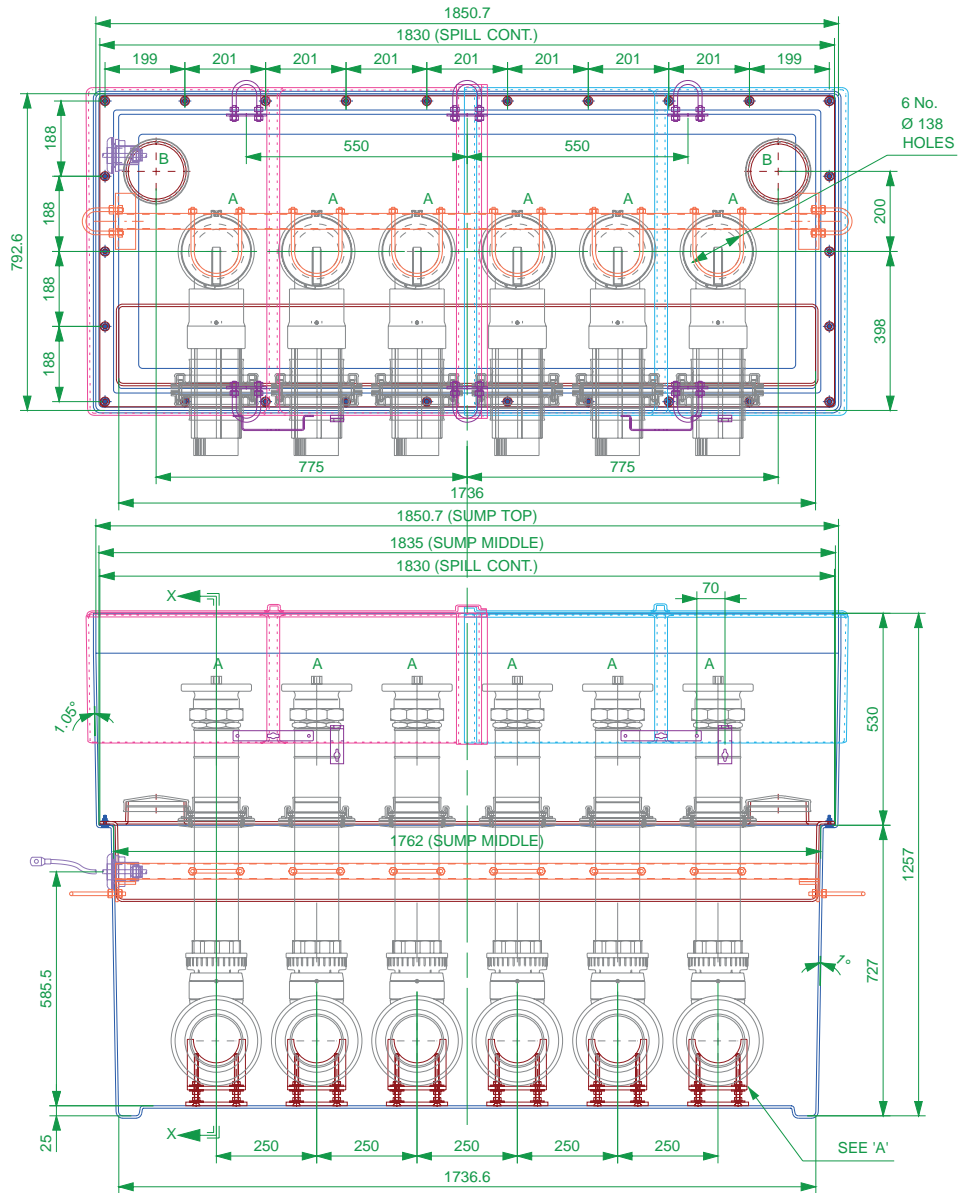

6 No.  
Ø 138  
HOLES

A = Ø110/Ø125 FILL LINE (x6)  
B = OBSERVATION PORT (x2)

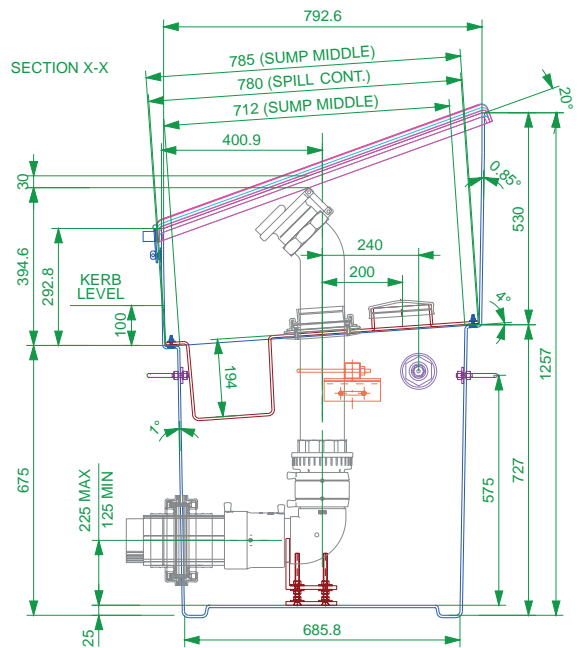
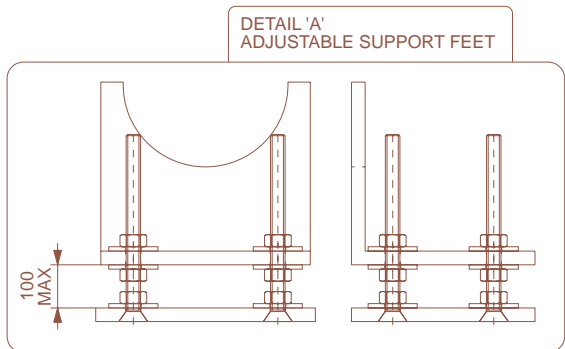

1737 x 686 x 1257mm deep GRP above ground fill sump with hinged double door to fit up to 6 fill lines. System includes internal spill tray, pipework support rail and concrete tie fixings.

For reference purposes only. This drawing is not a specification. Order against product code only. To enable continuous improvement of our products, the designs and specifications are subject to change without notice.

**FIBRELITE**   
PART OF OPW A DOWER COMPANY



PEA GRAVEL



CONCRETE

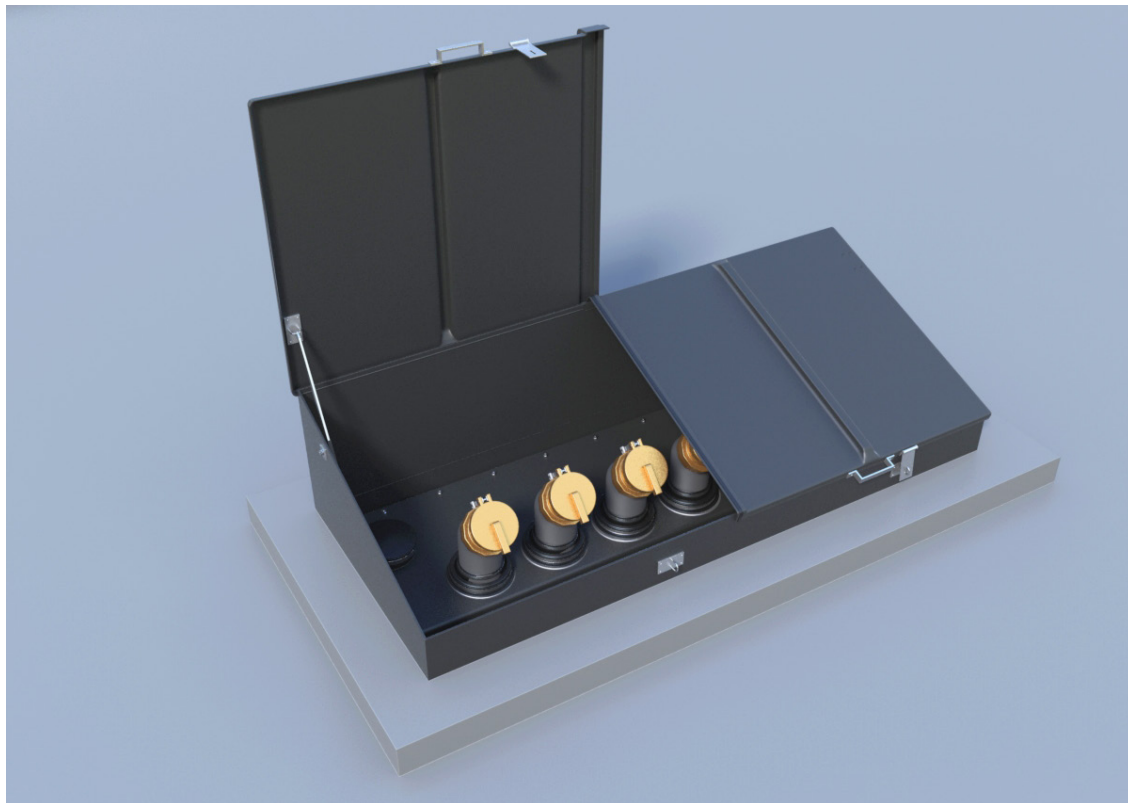
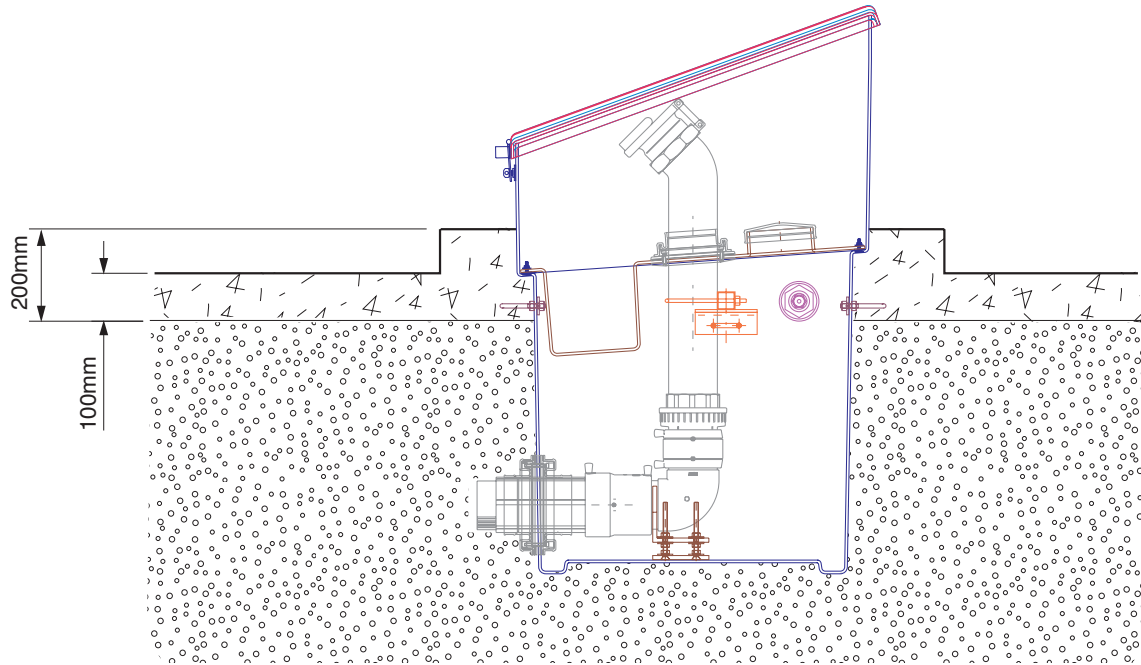

1737 x 686 x 1257mm deep GRP above ground fill sump with hinged double door to fit up to 6 fill lines. System includes internal spill tray, pipework support rail and concrete tie fixings.

For reference purposes only. This drawing is not a specification. Order against product code only. To enable continuous improvement of our products, the designs and specifications are subject to change without notice.